

# Himel

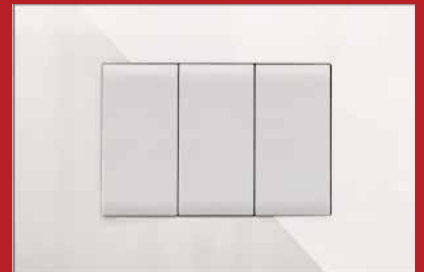
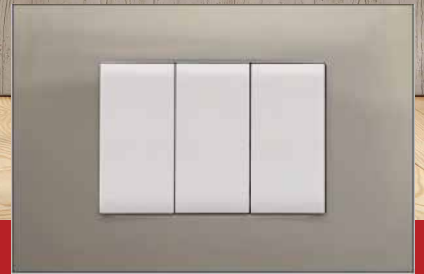
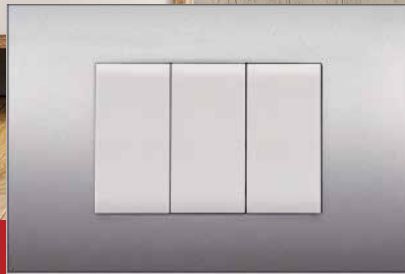

**FLEXO  
SERIES**

[www.himel.com](http://www.himel.com)

# Flexo Series

Modular Wiring Devices

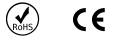

## Range Presentation

Introducing our most flexible wiring devices range designed to elevate your living and working spaces, Flexo. Crafted from fire-retardant, high-quality polycarbonate, Flexo offers a versatile combination of switches, sockets, frames, and accessories.

With a wide range of cover sizes and sockets featuring child protection shutters, each product is meticulously designed for safety and convenience.

Flexo is certified for CE and RoHS standards, ensuring best-in-class quality and compliance.

## Features



Versatile combination of switches, sockets, frames and accessories



Wide range of cover sizes



Made from polycarbonate, one of the toughest thermoplastics available



Sockets available with shutter for child protection



CE and RoHS certification

## Product Dimension (mm)

### SWITCH & SOCKET

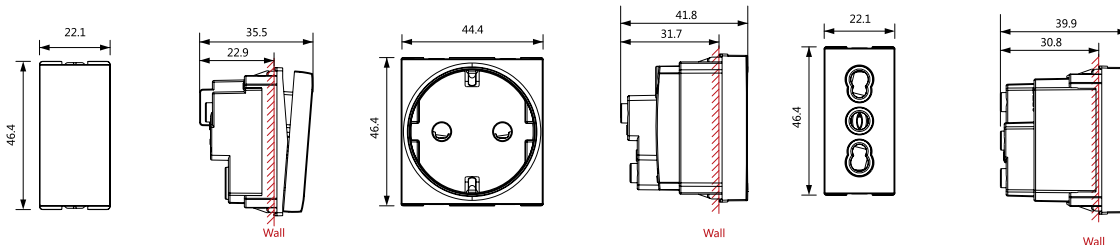

### FRAME

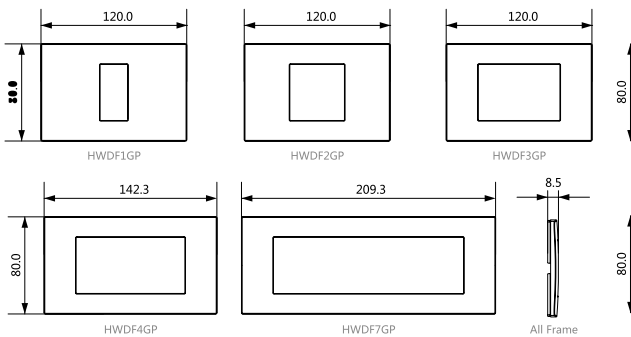

### MODULE

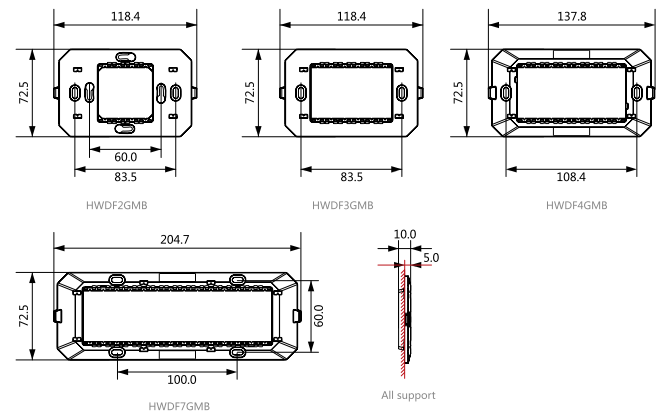



## Installation System

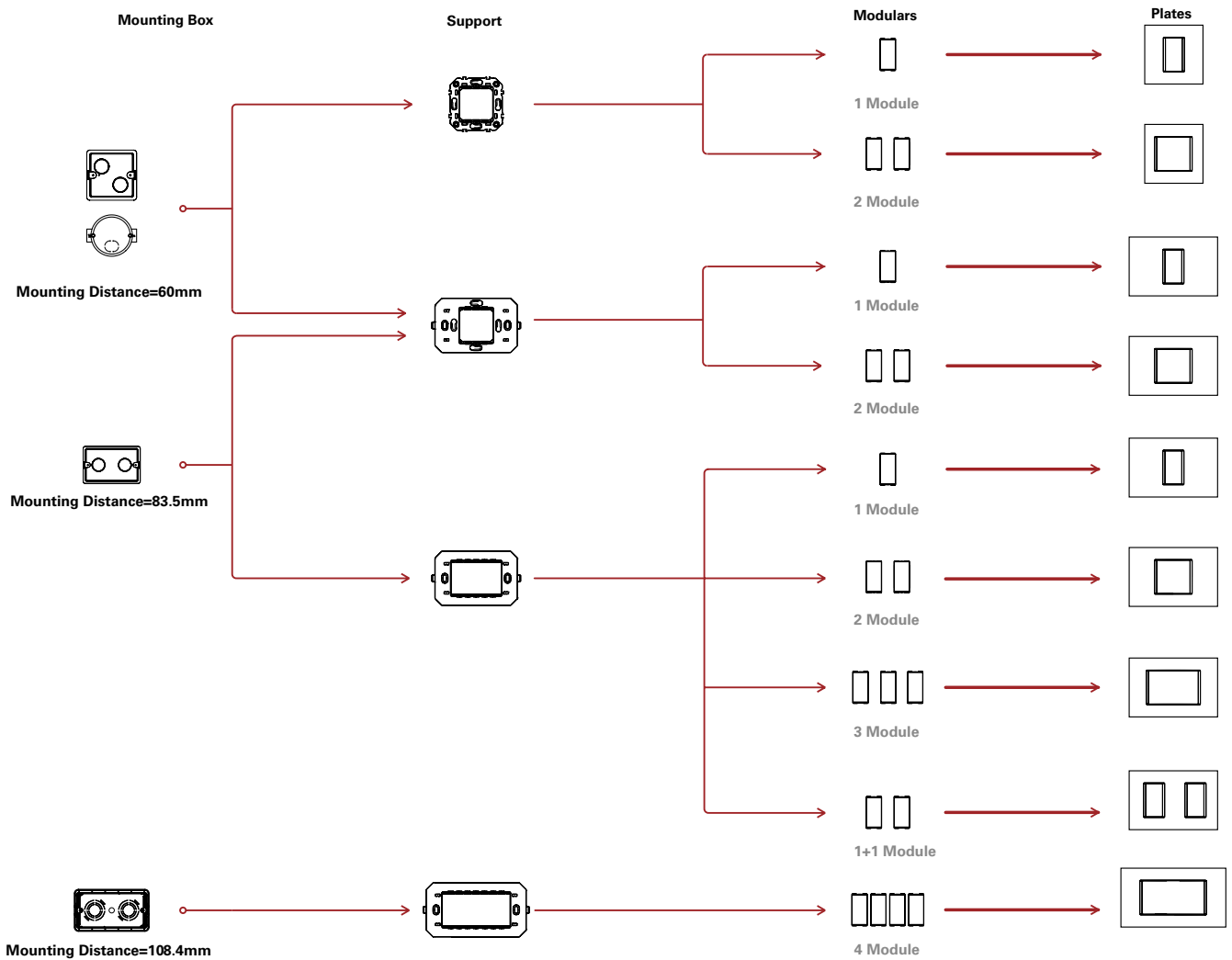

# Flexo Series

Modular Wiring Devices



## Selection Code

Range name

**HWDF**

**F:** Flexo

Functionality

**XXX**

You may replace XXX codes by functionality codes listed below

Colour

**X**

**Default:** White  
**B:** Black  
**S:** Silver  
**C:** Champagne

## Frame Colour Choices



silver



champagne



black



white

## Module Colour Choices



black















white

## Major Functionality Abbreviation

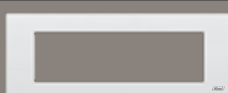
1G1W: 1 gang 1 way  
1G2W: 1 gang 2 way  
PB: push button

IS: Italian socket  
SS: schuko socket  
DIM: dimmer

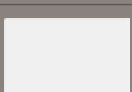
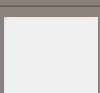
## Frame

Product Picture	Ref No. (white)	Ref No. (black)	Ref No. (silver)	Ref No. (champagne)	Description	Mod	Qty/Box	Qty/ Carton
	HWDFEP1G	HWDFEP1GB	HWDFEP1GS	HWDFEP1GC	1 Gang Frame - 80 size 80 x 80 x 8.5 (mm) PC	1	30	300
	HWDFEP2G	HWDFEP2GB	HWDFEP2GS	HWDFEP2GC	2 Gang Frame - 80 size 80 x 80 x 8.5 (mm) PC	2	30	300
	HWDF1GP	HWDF1GPB	HWDF1GPS	HWDF1GPC	1 Gang Frame - 120 size 120 x 80 x 8.5 (mm) PC	1	20	200
	HWDF2GP	HWDF2GPB	HWDF2GPS	HWDF2GPC	2 Gang Frame - 120 size 120 x 80 x 8.5 (mm) PC	2	20	200
	HWDFL2GP2	HWDFL2GP2B	HWDFL2GP2S	HWDFL2GP2C	2 Gang Frame - 120 size 120 x 80 x 8.5 (mm) PC	1+1	20	200
	HWDF3GP	HWDF3GPB	HWDF3GPS	HWDF3GPC	3 Gang Frame - 120 size 120 x 80 x 8.5 (mm) PC	3	20	200
	HWDF4GP	HWDF4GPB	HWDF4GPS	HWDF4GPC	4 Gang Frame 147 x 80 x 8.5 (mm) PC	4	20	200
	HWDF7GP	HWDF7GPB	HWDF7GPS	HWDF7GPC	7 Gang Frame 209 x 80 x 8.5 (mm) PC	7	16	160
	HWDFL2GPE	HWDFL2GPEB	HWDFL2GPES	HWDFL2GPEC	2x1 Gang Frame 120 x 120 x 8.5 (mm) PC	2x1	10	100
	HWDFL2GPG	HWDFL2GPGB	HWDFL2GPGS	HWDFL2GPGC	2x(1+1) Gang Frame 120 x 120 x 8.5 (mm) PC	2x (1+1)	10	100
	HWDFL2GPF	HWDFL2GPFB	HWDFL2GPFS	HWDFL2GPFC	2x3 Gang Frame 120 x 120 x 8.5 (mm) PC	2x3	10	100
	HWDFL3GBP	HWDFL3GBPB	HWDFL3GBPS	HWDFL3GBPC	3 Gang Blank Plate 120 x 80 x 8.5 (mm) PC	3	20	200
	HWDFL2X3GBP	HWDFL2X3GBPB	HWDFL2X3GBPS	HWDFL2X3GBPC	2x3 Gang Blank Plate 120 x 120 x 8.5 (mm) PC	2x3	10	100
	HWDFLCO	HWDFLCOB	HWDFLCO S	HWDFLCO C	Cable Outlet 80 x 120 x 8.5 (mm) PC	3	20	200

# Flexo Series

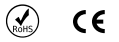

Modular Wiring Devices





## Support

Product Picture	Ref No.	Description	Terminal	Mod	Qty/Box	Qty/Carton
	HWDFEP2GMB	2 Gang Support w/o Mounting Claw	-	Max. 2 mod	30	300
	HWDFLEP2GMBC	2 Gang Support with Mounting Claw	-	Max. 2 mod	20	200
	HWDF2GMB	2 Gang Support	-	Max. 2 mod	20	200
	HWDF3GMB	3 Gang Support	-	Max. 3 mod	20	200
	HWDF4GMB	4 Gang Support	-	Max. 4 mod	20	200
	HWDF7GMB	7 Gang Support	-	Max. 7 mod	16	160
	HWDFL2X3GMB	2X3 Gang Support	-	Max. 2 x 3 mod	10	100



## One Way Switches

Product Picture	Ref No. (White)	Ref No. (Black)	Description	Terminal	Mod	Qty/Box	Qty/Carton
	HWDF1G1W HWDFL2G1W HWDFL3G1W	HWDF1G1B HWDFL2G1B HWDFL3G1B	1 Way Switch 1P 250V~16AX	Screw	1 2 3	20 14 12	200 140 120
	HWDF1G1WLED HWDFL2G1WLED HWDFL3G1WLED	HWDF1G1WLEDB HWDFL2G1WLEDB HWDFL3G1WLEDB	1 Way Illuminable Switch(with LED indicator) 1P 250V~16AX	Screw	1 2 3	20 14 12	200 140 120

## Two Way Switches

Product Picture	Ref No. (White)	Ref No. (Black)	Description	Terminal	Mod	Qty/Box	Qty/Carton
	HWDF1G2W HWDFL2G2W HWDFL3G2W	HWDF1G2WB HWDFL2G2WB HWDFL3G2WB	2 Way Switch 1P 250V~16AX	Screw	1 2 3	20 14 12	200 140 120
	HWDFL1G2WLED HWDFL2G2WLED HWDFL3G2WLED	HWDFL1G2WLEDB HWDFL2G2WLEDB HWDFL3G2WLEDB	2 Way Illuminable Switch(with LED indicator) 1P 250V~16AX	Screw	1 2 3	20 14 12	200 140 120

## Push Button

Product Picture	Ref No. (White)	Ref No. (Black)	Description	Terminal	Mod	Qty/Box	Qty/Carton
	HWDFPB HWDFLPB2G HWDFLPB3G	HWDFPBB HWDFLPB2GB HWDFLPB3GB	Push Button 1P 250V~ 10A	Screw	1 2 3	20 14 12	200 140 120
	HWDFLPB1GLED HWDFLPB2GLED HWDFLPB3GLED	HWDFLPB1GLEDB HWDFLPB2GLEDB HWDFLPB3GLEDB	Illuminable Push Button (with LED indicator) 1P 250V~ 10A	Screw	1 2 3	20 14 12	200 140 120

## Double Pole Switches

Product Picture	Ref No. (White)	Ref No. (Black)	Description	Terminal	Mod	Qty/Box	Qty/Carton
	HWDFLDP1G HWDFLDP2G HWDFLDP3G	HWDFLDP1GB HWDFLDP2GB HWDFLDP3GB	Double Pole Switch 2P 250V~16AX	Screw	1 2 3	20 14 12	200 140 120
	HWDFLDP1GLED HWDFLDP2GLED HWDFLDP3GLED	HWDFLDP1GLEDB HWDFLDP2GLEDB HWDFLDP3GLEDB	Illuminable Double Pole Switch (with LED indicator) 2P 250V~16AX	Screw	1 2 3	20 14 12	200 140 120

# Flexo Series

Modular Wiring Devices

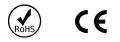

## Intermediate Switches

Product Picture	Ref No. (White)	Ref No. (Black)	Description	Terminal	Mod	Qty/Box	Qty/Carton
	HWDFIS HWDFLIS2G HWDFLIS3G	HWDFISB HWDFLIS2GB HWDFLIS3GB	Intermediate Switch 1P 250V~16AX	Screw	1 2 3	20 14 12	200 140 120

## 1-0-2 Mode Blind Switches

Product Picture	Ref No. (White)	Ref No. (Black)	Description	Terminal	Mod	Qty/Box	Qty/Carton
	HWDF3SCS HWDFL3SCS2G HWDFL3SCS3G	HWDF3SCSB HWDFL3SCS2GB HWDFL3SCS3GB	1-0-2 Mode Blind Switch 1P 250V~ 10A	Screw	1 2 3	20 14 12	200 140 120

## Electrical Sockets





Product Picture	Ref No. (White)	Ref No. (Black)	Description	Terminal	Mod	Qty/Box	Qty/Carton
	HWDFSS	HWDFSSB	Schuko Socket with Safety Shutter 16A 250V~ 2P+E	Screw	2	8	80
	HWDFLSSLID01	HWDFLSSLID01B	Schuko Socket with Safety Shutter with Lid 16A 250V~ 2P+E	Screw	2	8	80
	HWDFLESUNI	HWDFLESUNIB	Universal European Socket with Safety Shutter 16A 250V~ 2P+E	Screw	2	8	80
	HWDFL10IS	HWDFL10ISB	10A Italian Socket with Safety Shutter 10A 250V~ 2P+E	Screw	1	16	160
	HWDF16IS	HWDF16ISB	10A/16A Universal Italian Socket with Safety Shutter 10A/16A 250V~ 2P+E	Screw	1	16	160

## Accessories







Product Picture	Ref No. (White)	Ref No. (Black)	Description	Terminal	Mod	Qty/Box	Qty/Carton
	HWDFLLEDI001	-	LED indicator for screwless terminal switch	-	-	50	5000
	HWDFLLEDI002		LED indicator for screw terminal switch				
	HWDFBF	HWDFBFB	Blank Insert	-	1	32	320



## VDI Sockets

Product Picture	Ref No. (White)	Ref No. (Black)	Description	Terminal	Mod	Qty/Box	Qty/Carton
 ○●	HWDFTS	HWDFTSB	Telephone Socket CAT3 RJ11	-	1	20	200
 ○●	HWDFDS	HWDFDSB	LAN Socket CAT5E RJ45 UTP	-	1	20	200
 ○●	HWDFTV	HWDFTVB	TV Socket Female Type End Type w/o Surge protection	-	1	20	200
 ○●	HWDFLSTV	HWDFLSTVB	End Type w/o Surge protection	-	1	20	200

## Electronics

Product Picture	Ref No. (White)	Ref No. (Black)	Description	Terminal	Mod	Qty/Box	Qty/Carton
 ○●	HWDFLMB	HWDFLMBB	Mechanical Buzzer 250V~	-	1	16	160
 ○●	HWDFLEDB	HWDFLEDBB	Electronic Doorbell 110-250V~	-	2	8	80
 ○●	HWDF1USB	HWDF1USBB	Single USB Charger Input 100-250V~ Output 5V DC 2.4A	-	1	16	160
 ○●	HWDF2USB	HWDF2USBB	USB + Type C Fast Charger Input 100-250V~ Output: A port / C port only: DC 5V 3A / 9V 2.2A / 12V 1.67A (20W) A+C port both in use: DC 5V 3A (15W)	-	1	16	160
 ○●	HWDFDIM25	HWDFDIM25B	Trailing Edge Dimmer 250V~ 250W Multi type load	-	1	16	160
 ○●	HWDFDIM50	HWDFDIM50B	Triac Dimmer 250V~ 500W Resistive type load	-	1	16	160
 ○●	HWDFDIM10	HWDFDIM10B	1-10V Dimmer For Fluorescent Lamp with Ballast	-	1	16	160



## Contact us



Get in touch with Himel Team at <https://www.himel.com/contact-us>



Find a Local Himel Distributor at <https://www.himel.com/find-a-distributor>



Reach Himel Global Team at [support@himel.com](mailto:support@himel.com)



Contact Global Himel Marketing and Communication Team at [sm.himel.communications@himel.com](mailto:sm.himel.communications@himel.com)



Visit Himel website at  
<https://www.himel.com>  
or  
Scan QR Code ▼



Learn More about Himel's  
15-Years of Value Engineering  
Excellence  
Scan QR Code ▼

